

MASTERLINE 8-HI DOORS DECO OUTWARD

MASTERLINE 8-HI GETEKEND
 MASTERLINE 8-HI DESSINE
 MASTERLINE 8-HI DRAWN
 MASTERLINE 8-HI GEZEICHENET

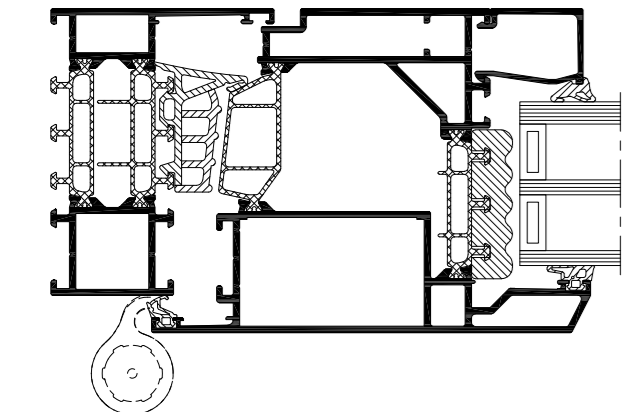

ISOLATIE VARIANT MASTERLINE 8
 ISOLATION VARIANTE MASTERLINE 8
 INSULATION VARIANT MASTERLINE 8
 ISOLATION VARIANTE MASTERLINE 8

MASTERLINE 8 STANDARD

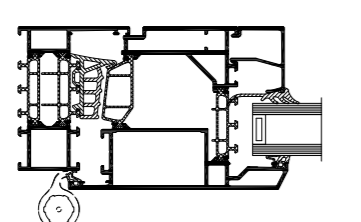

OVERZICHT OPENINGS TYPES RAAMDEUREN
 APERÇU TYPES D'OUVERTURE PORTE-FENETRE
 OVERVIEW OPENING TYPES WINDOW-DOOR
 ÜBERSICHT ÖFFNUNGSARTEN FENSTERTUER

RAAMDEUREN NAAR BUITENDRAAIEND
 PORTES-FENETRES OUVRANT VERS L'EXT.
 WINDOW-DOORS OUTWARD OPENING
 FENSTERTUEREN NACH AUSSEN OEFFNEND



 150a

RAAMDEUREN NAAR BUITENDRAAIEND
 PORTES-FENETRES OUVRANT VERS L'EXT.
 WINDOW-DOORS OUTWARD OPENING
 FENSTERTUEREN NACH AUSSEN OEFFNEND



 151a

PROFIELOVERZICHT
 APERÇU DES PROFILES
 PROFILE OVERVIEW
 PROFILUEBERSICHT

HULPPROFIELEN
 PROFILES DE RACCORDEMENT
 ADDITIONAL PROFILES
 ZUSATZPROFILE

 [Masterline 8 Window_Additional profiles.dwg](#)

BOUWAANSLUITINGEN
 RACCORDEMENTS AU BATIMENT
 BUILDING CONNECTIONS
 BAUANSCHLUESSE

 [... .dwg](#)

150a

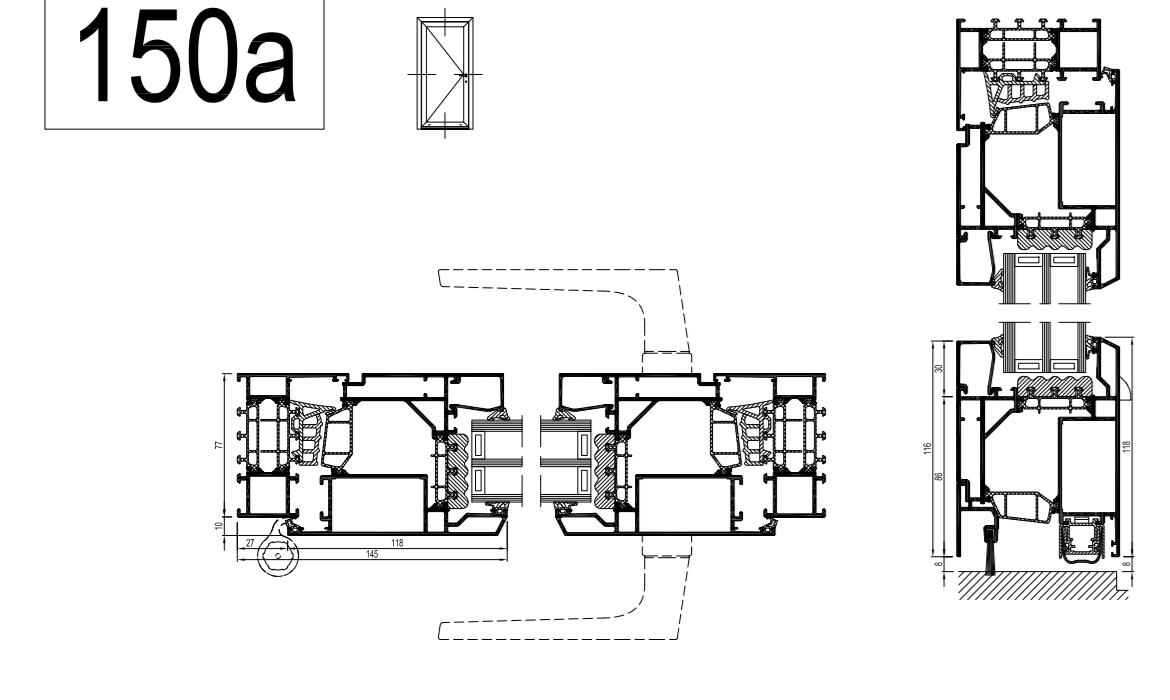

151a

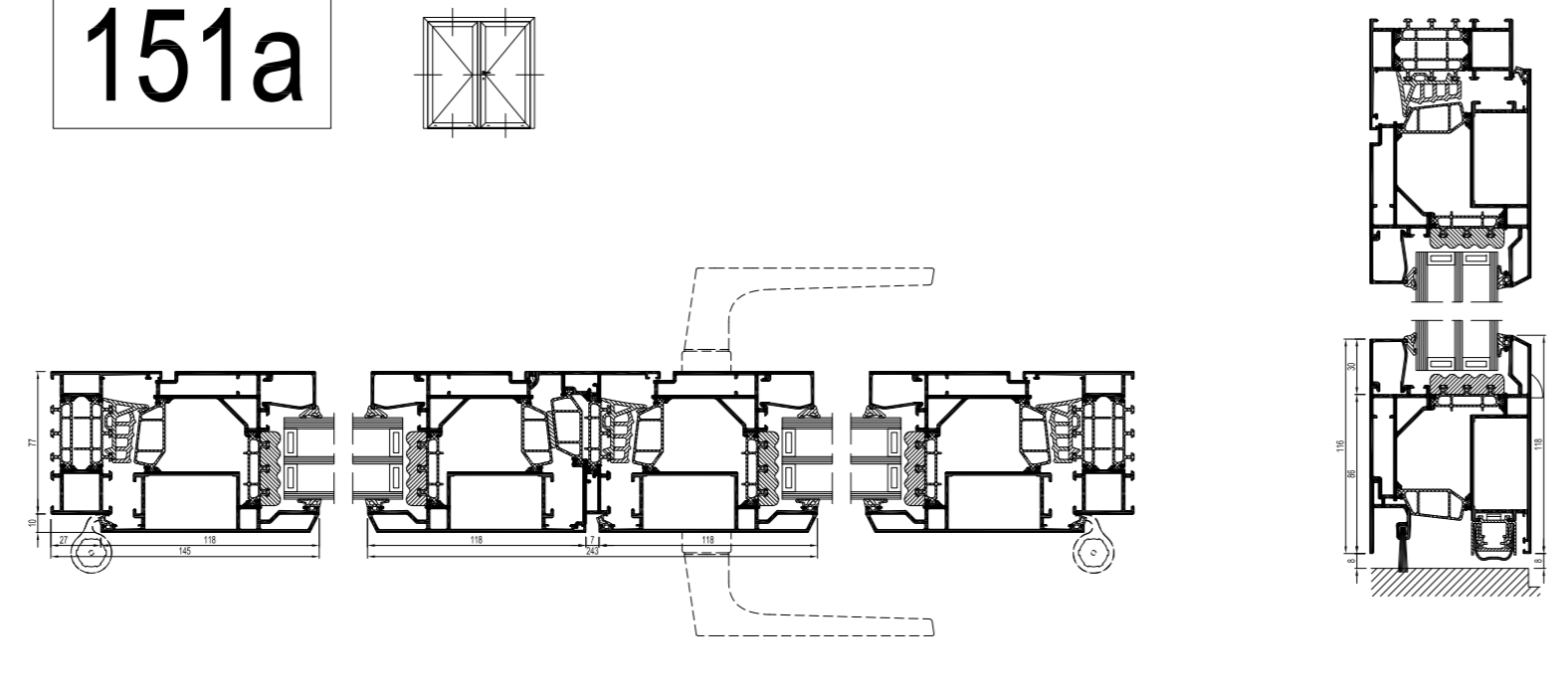

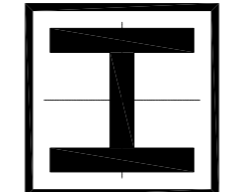
 PROFIELOVERZICHT
 APERÇU DES PROFILES
 PROFILE OVERVIEW
 PROFILUEBERSICHT

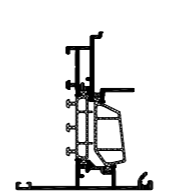
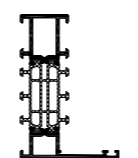
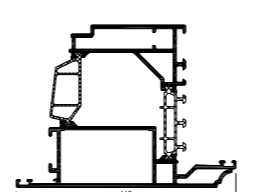
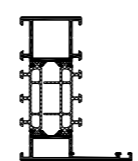
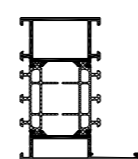
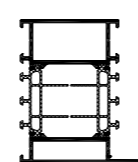
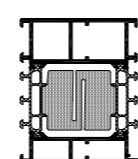
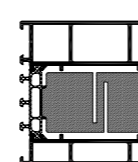
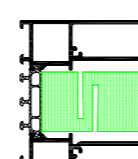
BUITENKADER DORMANT OUTER FRAME BLENDRAHMEN		STOLPPROFIEL BATTEE CENTRALE FEN. DOUBLE OUVR. DOUBLE CASEMENT PROFILE STULPPROFIL	
		VLEUGEL NAAR BUITENDRAAIEND OUVRANT VERS L'EXTERIEUR VENT OUTWARD OPENING FLUEGEL NACH AUSSEN OEFFNEND	
			
			
			
			
			
			

 DE PROFIELKEUZE WORDT BEPAALD DOOR DE MAXIMALE AFMETINGEN EN HET MAXIMALE GEWICHT VAN HET ELEMENT. NEEM CONTACT OP MET UW REYNAERS ALUMINIUM FABRIKANT OM DE JUISTE PROFIELKEUZE TE BEVESTIGEN.

LE CHOIX DU PROFILÉ EST DÉFINI PAR LES DIMENSIONS MAXIMALES ET LE POIDS MAXIMUM DE L'ÉLÉMENT. VEUILLEZ CONTACTER VOTRE FABRICANT REYNAERS ALUMINIUM POUR CONFIRMER LE BON CHOIX DE PROFILÉ.

THE PROFILE SELECTION IS DEFINED BY THE MAXIMUM DIMENSIONS AND WEIGHT OF THE ELEMENT. PLEASE CONTACT YOUR REYNAERS ALUMINIUM FABRICATOR TO CONFIRM THE RIGHT PROFILE SELECTION.

DIE PROFILAUSSWAHL WIRD DURCH DIE MAXIMALEN ABMESSUNGEN UND DAS GEWICHT DES ELEMENTS DEFINIERT. BITTE WENDEN SIE SICH AN IHREN REYNAERS ALUMINIUM HERSTELLER UM DEN RICHTIGEN PROFILAUSSWAHL ZU BESTÄTIGEN.